

# Poolpod Operation Manual

## Revision: Poolpod MarkZ

Published on 19-06-2015

The latest revision of this document is available at [poolpodproducts.com](http://poolpodproducts.com).



## Contents

1 PARTS AT A GLANCE.....	4
2 QUICK USER GUIDE.....	7
2.1 SWITCHING ON.....	7
2.2 MOVING UP AND DOWN THE POOLPOD BY THE REMOTE CONTROL.....	7
2.3 MOVING UP AND DOWN THE POOLPOD BY WRISTBAND.....	9
3 OVERVIEW OF YOUR POOLPOD MARK II.....	10
3.1 THE POOLPOD PLATFORM.....	10
3.2 THE USER CONTROLS.....	10
3.3 THE POOLPOD REMOTE CONTROL.....	11
3.4 THE POOLPOD WRISTBANDS.....	11
3.5 THE BATTERIES.....	12
3.6 THE POOLPOD WHEELCHAIR.....	12
4. OPERATING THE POOLPOD.....	13
4.1 SWITCHING ON THE POOLPOD.....	13
4.2 TURNING ON THE POOLPOD REMOTE CONTROL.....	14
4.3 TURN ON THE POOLSIDE CONTROL UNIT.....	14
4.4 USING THE REMOTE CONTROL.....	16
4.4.1 BUTTONS:.....	16
4.5 OPERATION MODES.....	16
4.5.1 REMOTE OPERATION MODE.....	17
4.5.1.1 SELECTING THE POOL (OPTIONAL EXTRA).....	17
A 'HOMING' THE POOLPOD.....	17
B. MOVING THE POOLPOD TO THE BOARDING POSITION.....	18
C. MOVING THE POOLPOD TO THE SWIM POSITION.....	18
D. RETURNING THE POOLPOD TO 'HOME'.....	19
E. TO EXIT THE POOL.....	19
4.5.2 INDEPENDENT MODE.....	21
4.5.2.1. AUTHORISING A USER.....	21
A. MOVING THE POOLPOD TO THE BOARDING POSITION (INDEPENDENT MODE).....	23
B. MOVING THE POOLPOD TO THE SWIM POSITION (INDEPENDENT MODE).....	23
C. RETURNING THE POOLPOD TO 'HOME' (INDEPENDENT MODE).....	23
D. TO EXIT THE POOL (INDEPENDENT MODE).....	24
4.5.3 INDEPENDENT MODE SEQUENCE (STAND UP).....	25
4.5.4 INDEPENDENT MODE SEQUENCE (WHEELCHAIR).....	26
4.6 MANUAL OPERATION - (RECOVERY MODE).....	27
5 CHARGE THE BATTERIES.....	29
5.1 WHEN TO CHARGE THE BATTERIES.....	29
5.2 CHARGING THE POOLPOD REMOTE CONTROL.....	29
5.3 CHARGING THE POOLPOD BATTERIES.....	30
6 RESPONDING TO STATUS MESSAGES.....	32
6.1 BATTERY DEPLETED.....	32
6.2 POOLPOD USER REQUEST.....	32
6.3 USER CONTROLS NOT DETECTED.....	32
7 FAULT CONDITION MESSAGES & TROUBLESHOOTING.....	33
7.1 FAULT: BROKEN CHAIN DETECTED.....	33
7.1.1 TO OVERRIDE.....	33
7.2 FAULT: DOOR CLOSE FAILURE DETECTED.....	34

7.3	FAULT: DOOR OPEN FAILURE DETECTED.....	34
7.4	FAULT: LOCK OPEN FAILURE DETECTED.....	35
7.5	FAULT: LOCK CLOSE FAILURE DETECTED.....	35
7.6	FAULT: PUMP OVERLOAD DETECTED.....	36
7.7	FAULT: POSITION SENSING INCONSISTENT DETECTED.....	36
7.8	FAULT: SAFETY MONITOR PERMANENTLY TRIPPED.....	37
7.9	FAULT: LEFT RFID BUTTON PERMANENTLY PRESSED.....	37
7.10	FAULT: RIGHT RFID BUTTON PERMANENTLY PRESSED.....	37
7.11	FAULT: POWER ON SWITCH PERMANENTLY PRESSED.....	37
8	MOVING THE POOLPOD AROUND.....	38
8.1	PREPARING THE POOLPOD FOR TRANSPORTATION.....	38
8.2	INSERTING THE WHEEL-SETS AND JACKING UP THE POOLPOD.....	38
8.3	RELOCATING THE POOLPOD.....	38
8.4	RELOCATING THE ANCHOR POINTS:.....	39
9	EC DECLARATION OF CONFORMITY.....	41

## 1 Parts at a glance

- 1. Poolpod
  - a. Platform Controls
  - b. Platform Door
  - c. Battery Compartment
  - d. Recovery insert

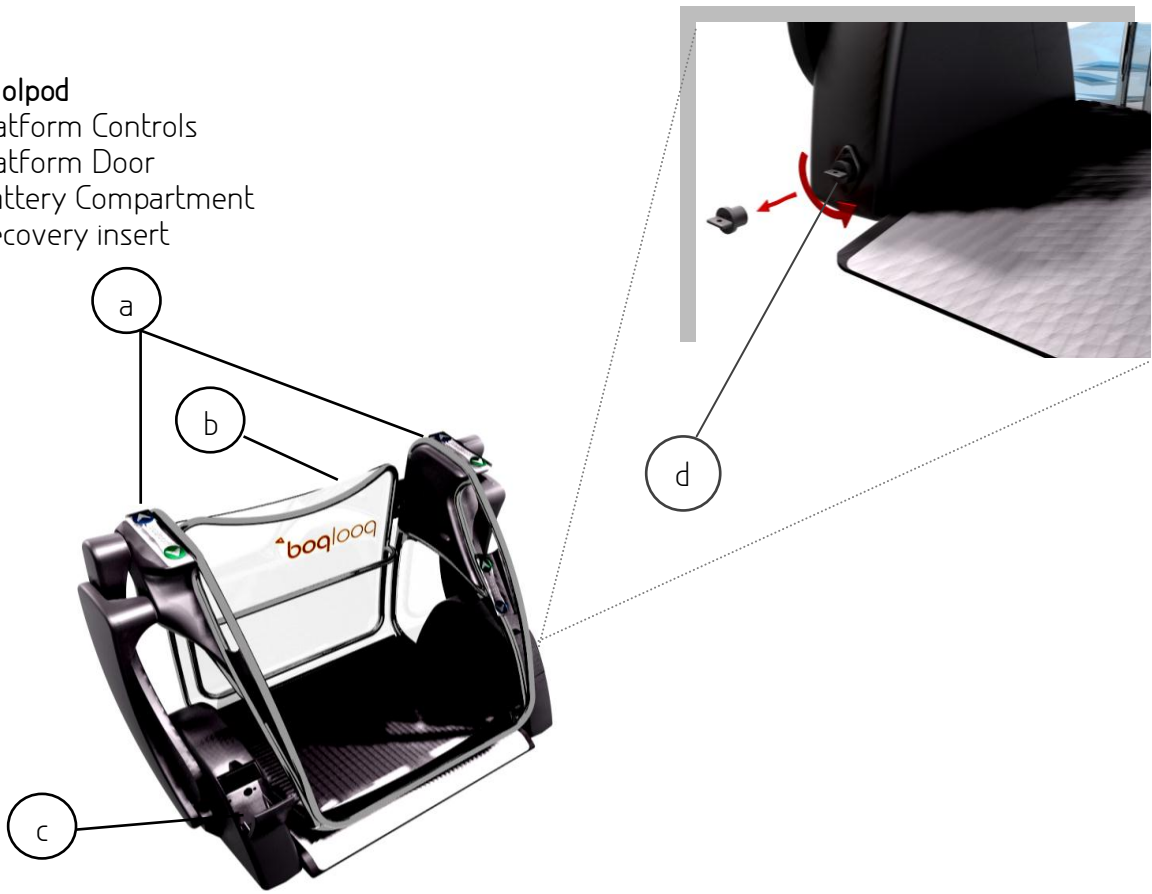

- 2. Poolside Control Unit
  - a. Battery Compartment
  - b. Poolside Controls

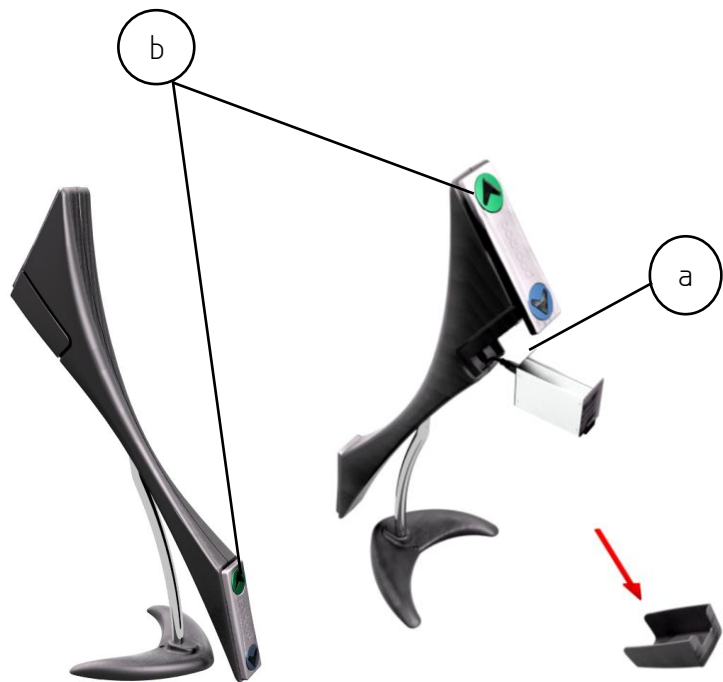

### 3. PoolPod Remote Control (PRC)

- a. Display
- b. Buttons
- c. Slot
- d. Remote Key

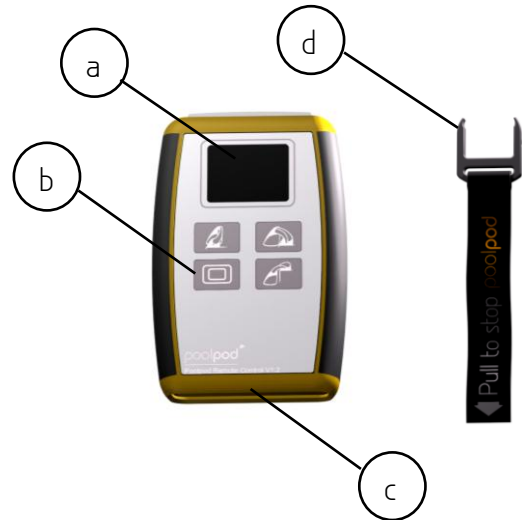

### 4. Wristband



b



### 5. Batteries and Battery charging Units.

- a. Battery A (PoolPod Platform)
- b. Battery B (Poolside Control Unit)
- c. Charging Unit

a

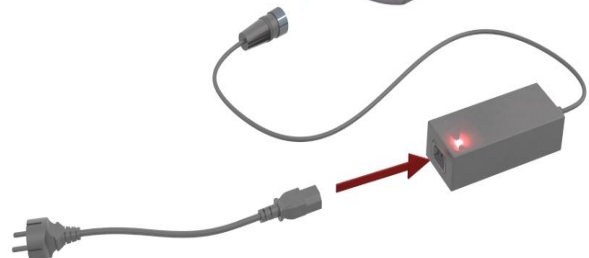
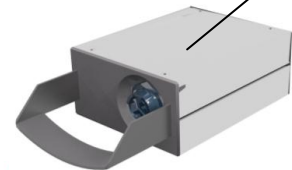

6. PoolPod Wheelchair

- a. Mainframe
- b. Hand Rim
- c. Foot Rest
- d. Seat Back
- e. Seat Base
- f. Push Bar
- g. Parking Brake
  - i. Lever Handle
  - ii. Pivot Bolts
  - iii. Brake Shoe
  - iv. WheelChair Tyre
- h. Lock-in Castor Forks
- i. Wheels & Pneumatic tyres

Parking Brake

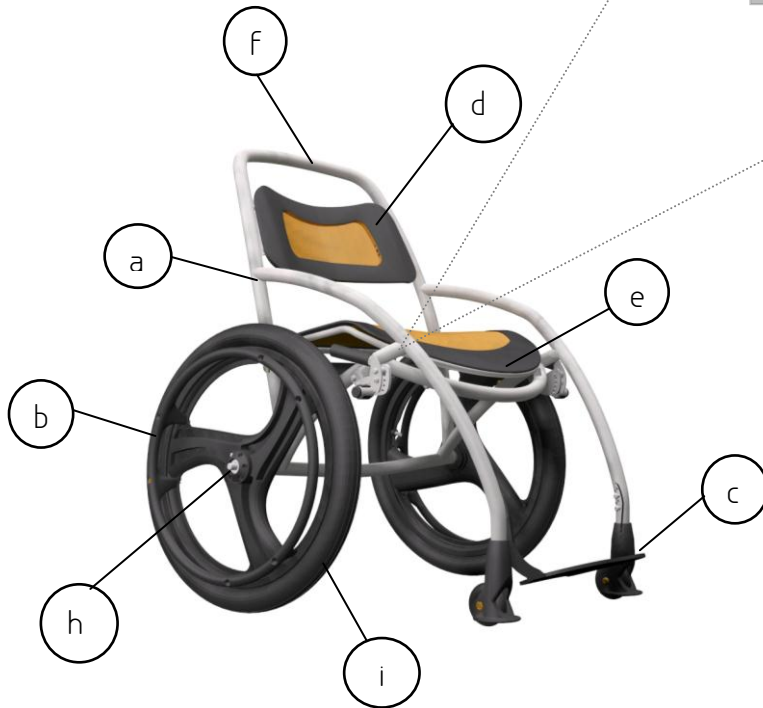
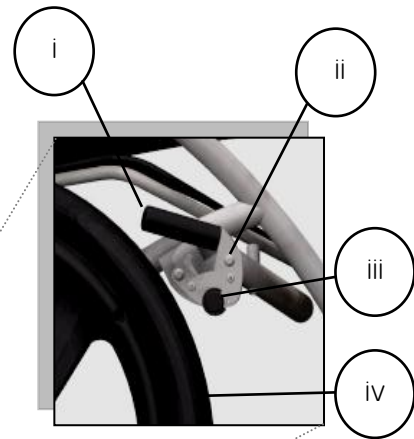

7. Trolleys

Trolleys

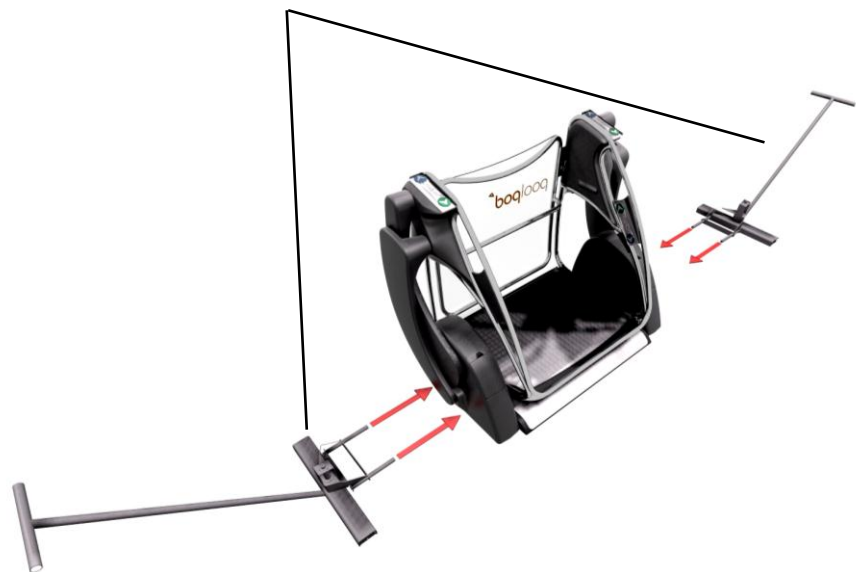

## 2 Quick User Guide

### 2.1 Switching on

- i. Turn on the PoolPod Platform using the switch inside the battery compartment.
- ii. Turn on the PoolPod Remote Control (PCR) by inserting the key in the slot at the bottom.
- iii. Optionally you may also turn on the Poolside Controls Unit using the switch located in the battery compartment.

*Note: Make sure the batteries required have been charged previously. See section 5 for further information.*

### 2.2 Moving the Poolpod up and down by the Remote Control

By using the PoolPod Remote Control (PCR) buttons the Poolpod can be moved up and down to 3 different positions. This allows the user to get in and out of the swimming pool.

1. **Home:** Moves the Poolpod to fully compact configuration.
2. **Load/Unload:** Moves the Platform level with the pool for entry and exit.
3. **Swim:** Moves the Poolpod Platform to a preset submerged depth.
4. **Squares:** Activates the Poolpod when a swimmer request to operate, by holding the wristband on any button on the PoolSide Control Unit or the Platform Controls.



**Caution:**

The remote control is designed to be wet but not to be submersed into the swimming pool.

### Steps sequence- Remote Operation Mode

1



2



Press and Hold the ' Home' button to move the Platform to storage position or home position.

Press and Hold the ' Load/Unload' button Position to move to the loading position and open the door in order to board.

This section illustrates the first two steps of the remote operation sequence. Step 1 shows the PoolPod platform in its upright 'home' position. Step 2 shows the platform tilted forward into a 'loading' position, with the door open. A red arrow points from step 1 to step 2.

3



4



To return the platform to its ' Home' position, Press and Hold the ' Home' button.

Press and Hold the ' Swim Position' button to close the door and submerge the PoolPod platform into the pool.

This section illustrates the final two steps of the remote operation sequence. Step 3 shows the platform tilted further forward into a 'swim' position, with the door closed. Step 4 shows the platform returned to its upright 'home' position. A red arrow points from step 3 to step 4.



## 2.3 Moving up and down the Poolpod by wristband

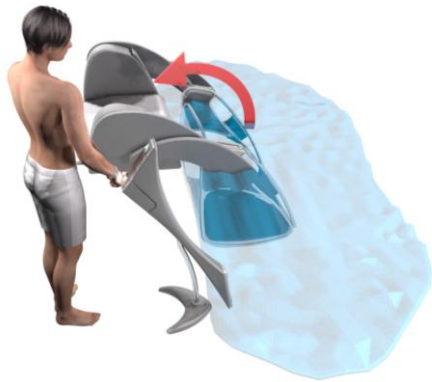

Hold the wristband over the blue illuminated button on the Poolside Control Unit. This will bring the Poolpod to the loading position and open the door.

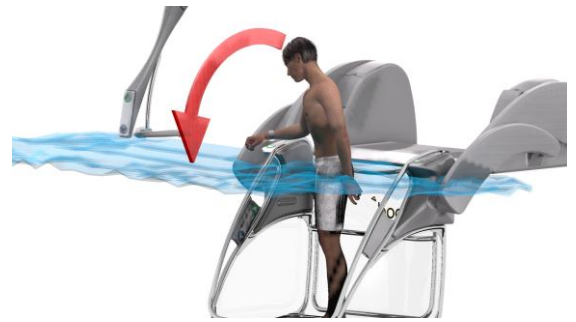

Enter the Poolpod platform. Hold the wristband over the blue illuminated down button on the Platform Control to close the door and move down into the swimming pool.

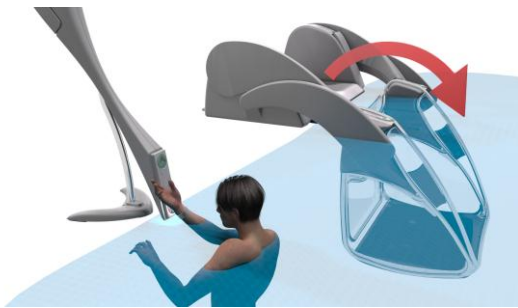

When ready to exit the pool, the swimmer must call the Poolpod Platform back down into the water by holding the wristband over the blue illuminated down button on the Poolside Control.

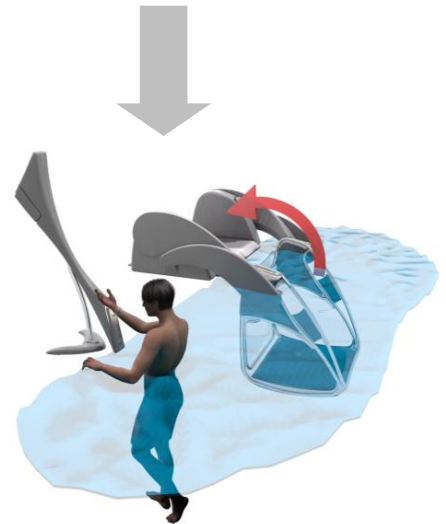

To return the platform to home position: Hold the wristband on the green illuminated up button on a Platform Control to return the platform to 'Home' position. The swimmer can now use the pool.



To move up and exit the Pool Pod Platform, Hold the wristband over the green illuminated button on Pool Pod Platform.

Note: All the movements requested by the wristband will generate an alert in the Poolpod Remote Control (PRC) requesting authorisation. The Pool Attendant should authorise by **Pressing** and **Holding** the 'squares' button on the PRC until the user has completed the desired movement. For further information see the section 4 Operating the Poolpod.

## 3. Overview of your PoolPod Mark II

### 3.1 The PoolPod Platform

The Poolpod Platform provides dignified and independent access for swimmers who find it hard to get in and out of swimming pools. The Poolpod Platform is made of 316 grade stainless, powered by a rechargeable battery. The Poolpod platform is semi-portable, easy to install and moved away from the pool side for storage or relocation.

The door across the back of the platform is automatic - like doors on regular passenger lifts. There is a set of controls on each side of the lift. The wheelchair automatically locks in place



on the platform. The generous 250Kgs lifting capacity means two users can enter the water and that service providers do not exclude heavier disabled people from their facilities.

### 3.2 The user controls

The Poolside control unit has lift call and lift return controls for users at the poolside and those in the pool.

For users in the pool the blue lift call button close to the water is used to move the

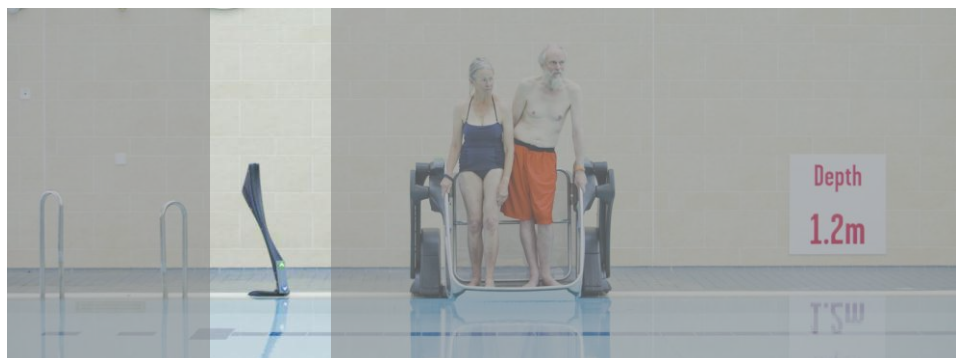

platform into the pool, so that a customer can get on board. The green button is used to return the lift to the poolside after entry to the pool. For a user entering the water the high up set of controls are provided, the blue button moves the Poolpod over the water. Next the door opens automatically so the pod is ready for boarding. The poolside controls are linked to the platform by a wireless system and are powered by rechargeable battery.

### 3.3 The Poolpod remote control

The Poolpod remote control (PRC) has a 4cm colour display and displays information on the battery status and the status of the poolpod. The simple 4 button design is used to move the pod between its 3 positions and the fourth button for special functions.

A plastic key must be inserted in the bottom of the remote to enable the system and this also acts as a pull stop cord that can be pulled in an emergency.



### 3.4 The Poolpod wristbands

The wrist band is provided to users to control all movements of the Poolpod by placing the band against one of the illuminated buttons. They work using an embedded chip which is recognised by the Poolpod buttons when it is held within 5cm and they are 100% water proof.



### 3.5 The Batteries

The new Poolpod Mark II rechargeable batteries provide an enhanced capacity of 50 lifts fully into and out of the water. The chargers are mains powered. Typically systems are supplied with 2 batteries for continuous operation. *For previous version, please see appendix 1.*



### 3.6 The Poolpod wheelchair

The Poolpod wheelchair is durable all 316 Stainless steel structure with a fixed frame for reliability and low maintenance. It can be self-propelled or pushed. The soft seat material is a quick drying polyester PVC matrix that does not hold water or discolour in the pool environment. The chair comes with a chest strap that attaches to the backrest. The wheelchair automatically locks in place when on the platform lift. The poolpod wheelchair also looks the part on the poolside and in the shower and this chair will not give your facility the hospital feel that some other chairs can.



**WARNING!**

**SAFE WORKING LOAD IS TWO  
PERSONS WITH WHEELCHAIR OR  
A MAXIMUM OF 250KG (39 STONE)**

## 4. Operating the PoolPod

### 4.1 Switching on the Poolpod



a. Open the battery compartment in the Poolpod and insert the battery in the right orientation (socket top right hand).



b. Insert the power plug in the battery.

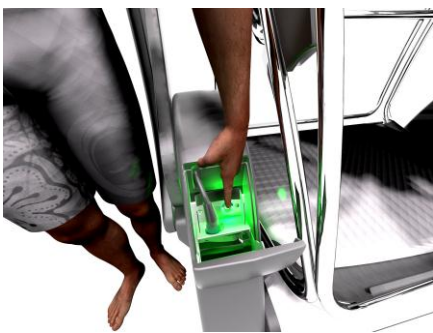

c. Tap the power button, it will illuminate in green colour and the platform controls will also illuminate.



d. Close the battery compartment.

## 4.2 Turning on the PoolPod Remote Control



a. Insert the key in the slot at the bottom of the PoolPod Remote Control (PCR).

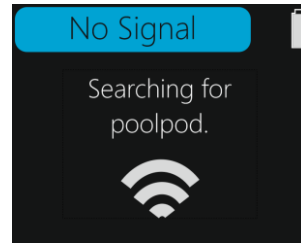

b. Screen: The screen confirms the processes the operator has asked the PoolPod to carry out. It also displays battery life, wireless connection status and any warnings or system faults.

## 4.3 Turn on the Poolside Control Unit

This function is optional for operation of the PoolPod with the wristband (See section: 4.5.2 independent mode).



a. Open the battery compartment cover on the PoolSide Control Unit.



b. Insert the power plug into the battery.



c. Tap the power button located inside the battery holder and this will illuminate green.



d. Insert the battery.



e. Close the battery compartment.

Note: Make sure that all the batteries required are charged previously. See section 5 for further information.

## 4.4 Using the Remote Control

### 4.4.1 Buttons:

a. **Home:** Returns Poolpod to fully compact configuration also know as 'Home'.

b. **Squares:** Activates the Poolpod when a swimmer requests to operate, by holding their wristband against any button on the Poolside Control Unit or Platform.

c. **Load/ Unload Position:** Moves the Poolpod to the loading position where the door opens allowing the user to enter or exit the platform at deck level.

d. **Swim Position:** Moves the Poolpod to the position where the platform is submerged to a pre-set depth to allow the user to swim from the platform or return, to exit the water.

e. **Remote Key:** The Remote Key is required to switch on and switch off the remote control. Pull the cord to stop the PoolPod.



## 4.5 Operation Modes

There are currently three modes of operation.

1. **Remote Operation Mode** - Pool Attendant's operation.
2. **Independent Mode** - User operated using proximity wristbands.
3. **Manual Operation** - Manual recovery. (only after battery has been removed)



## 4.5.1 Remote Operation Mode.

Using the PoolPod Remote Control (PCR) the Pool Attendant will be able to control the PoolPod using the buttons as described below.

### 4.5.1.1 Selecting the pool (optional extra)

The Poolpod can be programmed with multiple depths to suit different pool locations. This is required when a single unit is moved between different pools on one site. Select the current location on the PRC to continue.

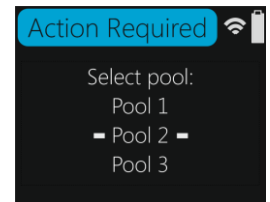

### A 'Homing' the PoolPod

Every time the Poolpod is switched on, the Pool Attendant must perform the Start Up Sequence for the Poolpod to become operational.

The Poolpod Remote Control will request you to 'Home' the Poolpod. **Press and Hold** the 'Home' button until the blue LEDs on the Platform Controls illuminate.

The Poolpod is now ready to use in either Independent or Remote Operation Mode.



## B. Moving the PoolPod to the boarding position

To move the platform out over the pool and open the door, **Press and Hold** the 'Load/Unload Position' button until the platform automatically stops and the door opens.



## C. Moving the PoolPod to the swim position

**Press and Hold** the 'Swim Position' button to close the door and submerge the PoolPod platform into the pool. The Platform will automatically stop at its programmed depth which will allow the swimmer to safely step out of or swim from the platform. The platform can be stopped at any desired depth by releasing the swim position button.



### D. Returning the PoolPod to ' Home'

To return the platform to its 'Home' position, simply **Press and Hold** the 'Home' button.



### E. To exits the pool.

To lift a swimmer back out of the pool lower the PoolPod as before by **Pressing and Holding** ' Swim' Position button. After the swimmer is on the PoolPod platform, **Press and Hold** the 'Load/Unload Position' button to bring them out of the water to the boarding position then the door will automatically open .





Caution: If anyone moves close to the Poolpod the operator must immediately release the button to stop and interrupt the movement.

In case of emergency, to STOP the Poolpod pull the KEY on the remote control, this immediately shuts the Poolpod down and all motion will cease.

### Steps sequence- Remote Operation Mode



A. Homing the Poolpod  
Press and Hold ' Home' 

B. Moving the Poolpod to boarding position  
Press and Hold the ' Load/Unload' 



D. Returning the Poolpod to ' Home' .  
Press and Hold ' Home' 

C. Moving the Poolpod to swimming position  
Press and Hold ' Swim' 

Note: For exit the pool move the poolpod to swim position as step C.

## 4.5.2 Independent Mode

The Independent mode allows the swimmer to operate the PoolPod independently by using the wristbands. The wristband should be attached around the user's wrist ready for use with the Poolpod. The wrist band has a wireless tag within and is synchronised with the Poolpod Platform, Poolside Control Unit and PoolPod Remote Control.



The wristband needs to be held within approximately 5 cm of the illuminated control buttons, the buttons communicate with the Poolpod Remote Control and request authorisation for the movement of the PoolPod

### 4.5.2.1. Authorising a user

The swimmer should place the wristband over an illuminated button on the Poolside Control Unit or Platform Controls, This will alert the Pool Attendant via the PoolPod Remote Control (PRC).

When authorisation of the Platform is required the PRC will flash, vibrate and display the authorisation screen.



#### 4.5.2.1.1 Modes of operation

The squares button is used to activate the illuminated control buttons.

##### Mode 1 ' Press and Hold'

If it is safe to operate the platform, the Pool Attendant should **Press** and **Hold** the ' squares' button until the user has completed their desired movement, the swimmer can stop the movement at any moment by separating the wrist band from the buttons.

This allows the user to take control of the PoolPod, stopping and starting as they desire.



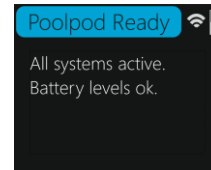
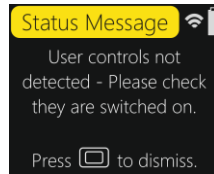

**Caution:** High vigilance is required by the pool attendant. Checks must be made for obstructions and hazards during operation. If anyone moves close to the Poolpod the pool attendant must immediately release the 'squares' button in order to stop the platform.

There are 2 more options for the PCR authorisation mode. In order to program these, please contact Poolpod Products.

#### **Mode 2 ' Press to authorise use for 5 min'**

In this mode when the squares button is pressed the user is able to move the Poolpod for 5 minutes, after which the illuminated control buttons are deactivated.

#### **Mode 3 ' Always Authorise'**

In this mode the PCR is set up in authorised mode all the time, the illuminated control buttons are permanently active, and the poolpod may be operated by users with the wristband at any time.

To stop the poolpod in emergency pull the " Remote key" out of the PCR and the system will safely slow to a stop, it will not reactivate until the key is reinserted in the PCR. Further details in section 4.5.1.

The remote key must be inserted in order to the platform work in all of these modes.

**Do not leave the Poolpod unattended when it is operating.**

### A. Moving the PoolPod to the boarding position (independent mode)

#### At the poolside control

Place the control wristband over the blue illuminated down button on the pool side control. The platform will move out over the water and open the door.

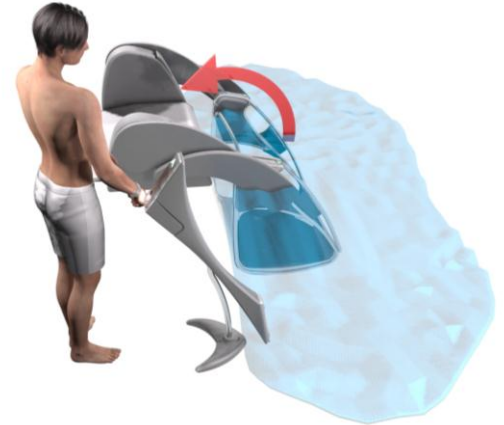

### B. Moving the PoolPod to the swim position (independent mode)

After entering the platform place the wristband on the nearest blue illuminated 'down' button (referred to as the platform controls) to close the door and move down into the pool.

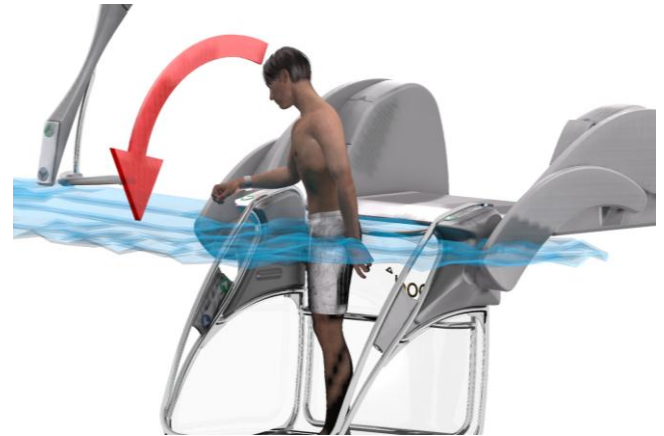

### C. Returning the PoolPod to 'Home' (independent mode)

The swimmer may now swim to the Poolside control and return the platform back up to its 'home' position. To do this, hold the wristband on the green illuminated 'up' button.

*It is important that a swimmer does this to ensure the PoolPod is ready for others to use and also so that the Poolpod does not obstruct other pool users.*

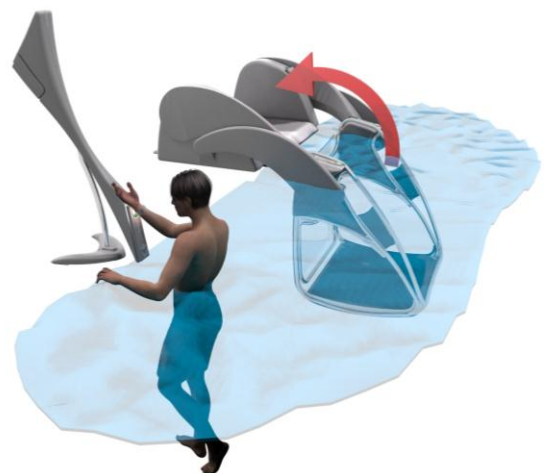

## D. To exit the pool (independent mode)

To get back out the pool the swimmer must call the PoolPod Platform back down into the water.

A. To do this they swim to the Poolside Control and hold the wristband against the blue illuminated 'down' button. This lowers the platform into the pool and it will automatically stop.

B. After entering the platform the swimmer may hold the wristband to the green illuminated 'up' button to lift themselves out of the Pool.

C. The platform will stop over the pool and the door will open allowing the swimmer to exit to the poolside.

D. Finally the Swimmer should move the platform to its 'Home' position: At the Poolside Control hold the wristband on the green illuminated 'up' button. This will close the door move the platform 'Home'.

*It is important that a swimmer does this to ensure the PoolPod is ready for others to use and also so that the Pod does not obstruct other pool users.*

All the movements requested by the wristband will generate an alert in the Poolpod Remote Control (PRC) requesting authorisation. The Pool Attendant should authorise by Pressing and Holding the 'squares' button on the PRC until the user has completed their desired movement.

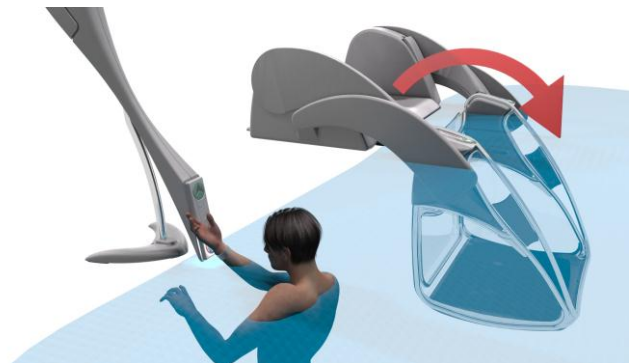



### 4.5.3 Independent Mode Sequence (stand up)

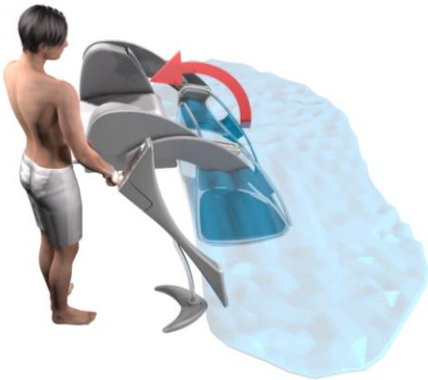

Place the wristband over the blue illuminated button on the Poolside Control Unit.

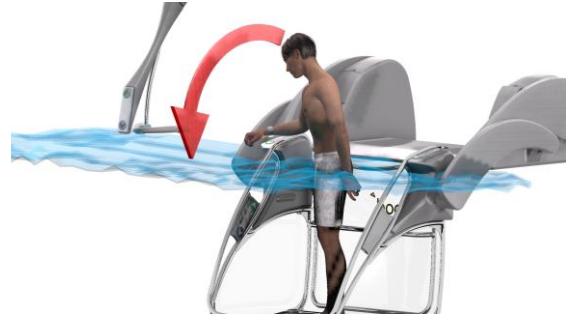

Enter to the Poolpod Platform. Place the wristband over the blue illuminated down button on the Platform Control to close the door and move down into the swimming pool.

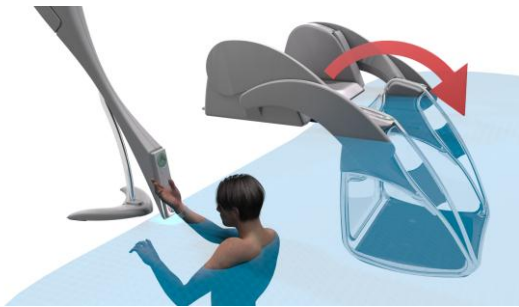

The swimmer must call the Poolpod Platform back down into the water holding the wristband over the blue illuminated down button in the Poolside Control.

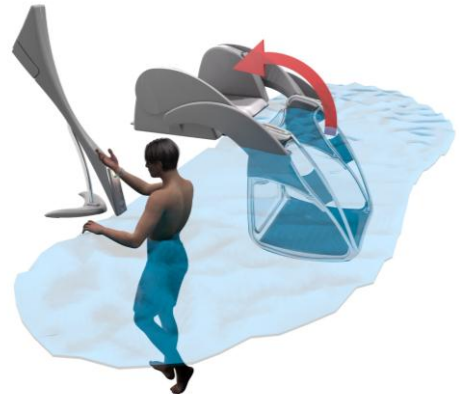

Return the platform to 'Home' position. Hold the wristband on the green illuminated up button on the Poolside Control to send the platform to 'Home' position.

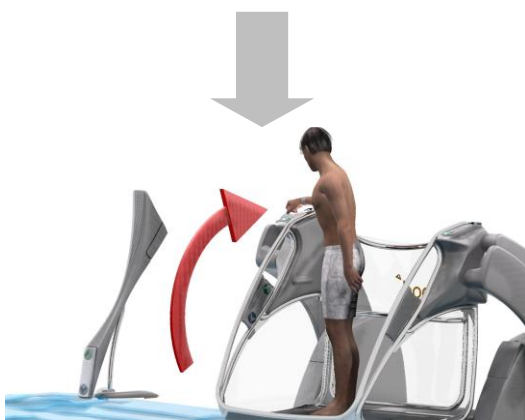

To lift and exit the Poolpod Platform, the swimmer may hold the wristband over the green illuminated button on Pool Pod Platform.

#### 4.5.4 Independent Mode Sequence (Wheelchair)



Place the wristband over the blue illuminated button on the Poolside Control Unit



Enter to the Poolpod Platform. Place the wristband over the blue illuminated down button on the Platform Control to close the door.

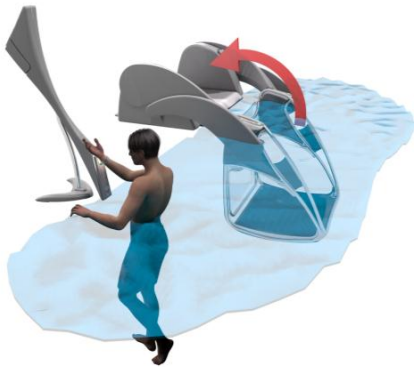

Return the platform to 'Home' position. Hold the wristband on the green illuminated up button on the Platform Control to send the platform back to 'Home' position.



Move down into the swimming pool.

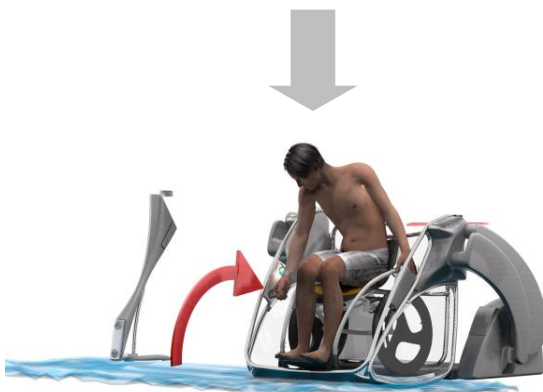

To lift and exit the Pool Pod Platform, the swimmer may hold the wristband over the green illuminated button on Pool Pod Platform.

Caution: Wheelchair weight 15 kg.  
When using the wheelchair on the platform the brakes should be applied to prevent undesired movements.  
Safe working Load for wheelchair: 100 kg.

Return the platform to 'Home' position. Hold the wristband on the green illuminated up button on the Platform Control to send the platform back to 'Home' position.

Move down into the swimming pool.

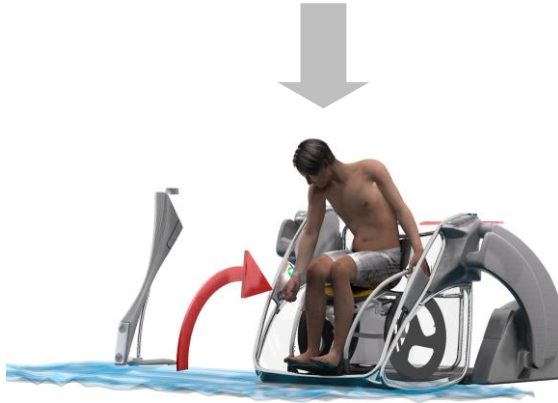

To lift and exit the Pool Pod Platform, the swimmer may hold the wristband over the green illuminated button on Pool Pod Platform.

Caution: Wheelchair weight 15 kg.  
When using the wheelchair on the platform the brakes should be applied to prevent undesired movements.  
Safe working Load for wheelchair: 100 kg.

#### 4.6 Manual Operation - (Recovery mode).

In the event of a system failure or the discharge of the battery resulting in the PoolPod failing to return to its home position, a Pool Attendant can manually operate the PoolPod.

The recovery tool is located within the Accessories case that is supplied with your Poolpod. This should be stored at a known location designated by the swimming pool management.

The manual operation sequence:

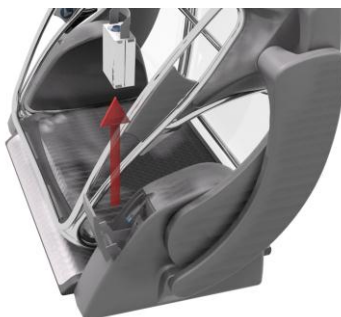

I. Remove the battery from the battery compartment.

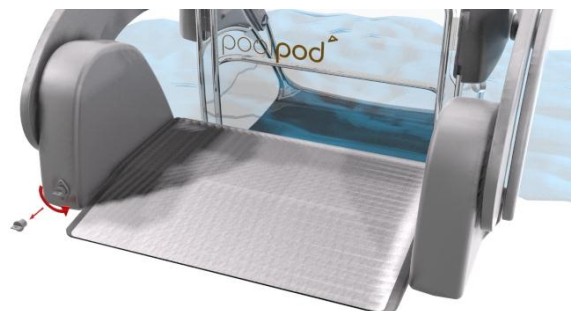

II. Unwind the recovery insert.



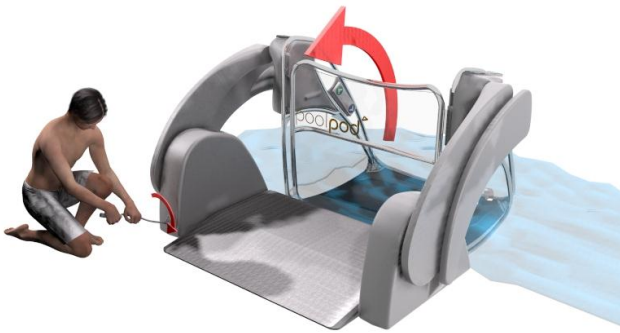

IV. If a swimmer or wheelchair user needs to leave the Platform, wind the recovery tool clockwise to move the Poolpod to the 'Load/Unload' position. Move the platform until it reaches the same level as the Poolpods ramp.

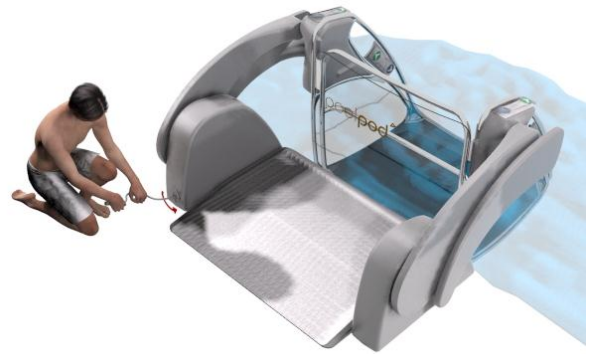

III. Insert the recovery tool socket in the recovery point located at the bottom left of the Poolpod base.



V. To open the door manually first release the door by pulling the lock to the right then pull to the open.



VI. After the occupants have left the platform ensure the door is fully closed and locked again.

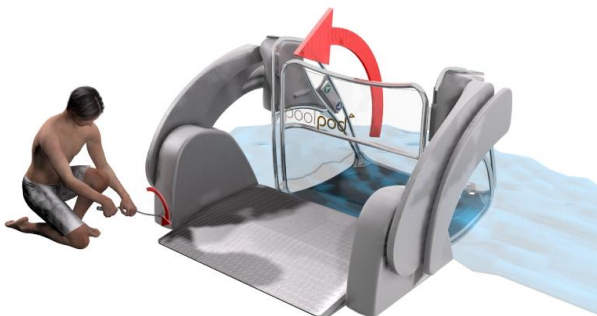

VII. Return the PoolPod to 'Home' position moving the platform as step IV. Do not overtravel the platform (move it too far back). Ensure that the front edge of the Platform is no further than just clear of the pool and that the underside of the platform does not make contact with the ramp.

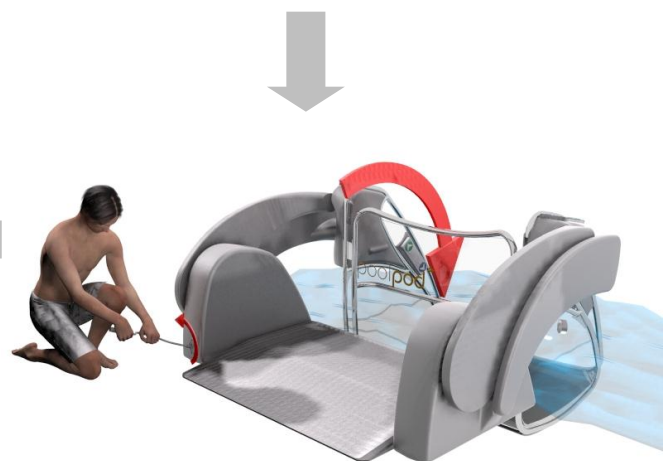

VIII. If it is necessary to move the PoolPod down, turn the handle anti clockwise.

Note: Refer to Section 7 Fault condition messages & troubleshooting as to why the Poolpod has failed to work correctly.

## 5 Charge the batteries

You must charge your Poolpod , PoolSide Control Unit and PoolPod Remote Control batteries to keep them operational.

### 5.1 When to charge the batteries

The Poolpod Remote Control (PRC) will indicate when the batteries are almost empty with the following messages on the display:

#### a. PoolPod

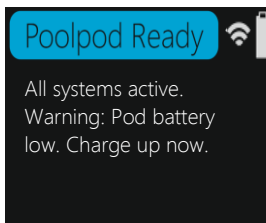

#### b. PoolSide Control Unit

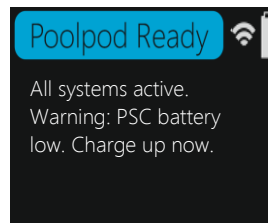

#### c. PoolPod Remote Control

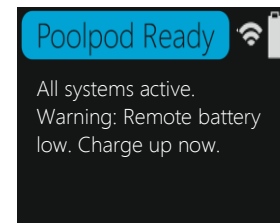

### 5.2 Charging the Poolpod Remote Control

1. Switch the PoolPod Remote Control (PRC) off by pulling the Remote Key from the slot.
2. Place the remote on the charging pad. A white light located at one of the charger's corners will illuminate, accompanied by an audible notification to signal that the PRC is charging.
3. When the PRC is fully charged the white light on the charging pad will switch off.
4. Switch the power off to the charging dock and remove the PRC.



Place the remote on the charging pad.

## 5.3 Charging the PoolPod batteries

### Charging Batteries A & B (Poolpod Lift & Poolside Control Unit)

1. Switch Charging Unit on using the switch at the mains socket. Connect the charging connectors by aligning the corresponding arrows on the battery and lead ensuring they 'click' to fully engage.

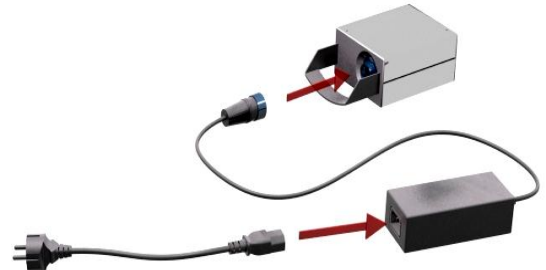

2. Ensure the light appears green on the charger

100-240V  
50/60 Hz



3. The batteries will start to charge and the green light on the charger will turn to red during the charging process.

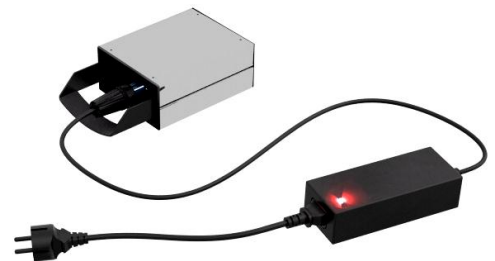

4. When the battery is fully charged, the light on the charger will turn back to green. Disconnect the battery from the charger by twisting the blue swivel sleeve and pulling on the connector to release.



Notes: Switch off the charger after use. For previous battery version, please see appendix 1.

The Poolpod Platform (25.9V) and Poolside Control Station (22.2V) are powered by rechargeable Li-Po batteries. It is important that the charging procedure is followed to ensure safe and full charge is achieved and also to prolong the life of the batteries.

The chargers are powered by 240V - 100V 50/60 Hz.

### Charging the Poolpod Battery

**Charging Cycle:** Up to 4 Hours\*

**Battery Life:** 80 cycles (depending on load)

### Charging PRC

**Charging Cycle:** 1 Hour

**Battery Life:** 12 Hours

### Charging Control Station

**Charging Cycle:** Up to 4 Hours\*

#### WARNING!

When using batteries and chargers:

• Only charge battery with poolpod designated li-po battery chargers

• Never leave batteries plugged in when fully charged

• Do not use if dropped onto hard surface or into water and contact poolpod assistance.

• Never leave batteries plugged in when power is turned off

• Never charge batteries in an area next to flammable materials

#### Caution:

When using batteries and chargers:

- Only charge battery with poolpod designated li-po battery chargers
- Never leave batteries unattended whilst charging
- Never leave batteries plugged in when fully charged
- Do not use if dropped onto hard surface or into water and contact poolpod assistance.
- Never leave batteries plugged in when power is turned off
- Never charge batteries in an area next to flammable materials

## 6 Responding to Status Messages

### 6.1 Battery depleted

The Poolpod platform battery is empty. Change and charge the battery immediately. Downward movement of the PoolPod Platform is disabled. The PoolPod Platform will automatically power down soon.

See section 5 charging the battery.

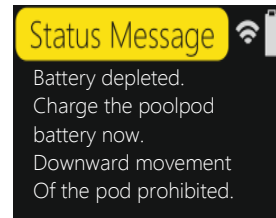

### 6.2 Poolpod user request

A user is trying to use the platform lift with a wristband.

See section 4.5.1 Authorising the user.

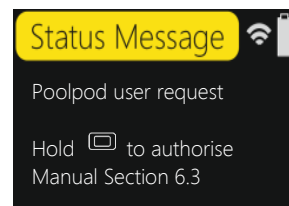

### 6.3 User Controls not detected

Poolside Control Unit has not been detected by the PoolPod Platform. Ensure that the Poolside Control Unit is switch on. See section 4.1.3

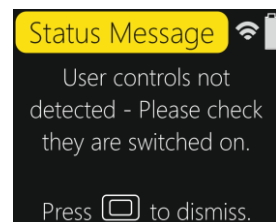



## 7 Fault condition messages & Troubleshooting

### Fault: Broken chain detected

This message indicates that a mechanical failure may have occurred. This could be several types of failure:

1. Failure of the chain that connects each side of the Poolpod.
2. Failure of the motor shaft.
3. Failure of the worm gearbox.
4. False signal of the fault from the monitoring system and or the sensors.

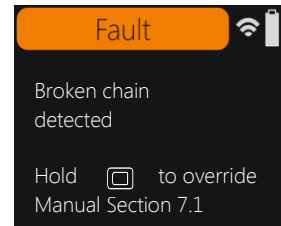

### 7.1.1 To Override

If you suspect that the monitoring system may be giving a false reading (condition 4) then you may override the sensor but you must only do so with extreme caution as this could cause irreparable damage to your Poolpod.

The chain sensor ensures that the sets of arms on each side of the Poolpod move in unison.

If you override the sensor signal you must check that the drive train is still connected to both sides of the Poolpod.

To do this insert the manual handle and wind the Poolpod towards or away from the pool. See section 4.6). If both sets of arms are moving in unison then the sensor reading is false and can be temporarily overridden.

Override by **Press** and **Hold** the squares button until the message is removed (roughly 2 seconds)

Important: If you operate the Poolpod with the chain sensor overridden then you must do the job of the chain sensor and ensure that at all times both sets of arms are moving together. If you suspect that one side is moving and the other is not then you must stop moving the poolpod immediately as to continue could risk the occupants and cause irreparable damage to your Poolpod.

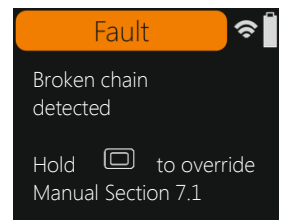

## 7.1 Fault: Door close failure detected

This message indicates that a mechanical failure may have occurred. This could be several types of failure, such as:

1. Something obstructing the door from closing.
2. Failure of the pneumatic piping connecting the pump module to the door actuator.
3. Failure of the compressor pump that drives the pneumatic cylinders.
4. Failure of the door close pneumatic valve.
5. Failure of the door closed sensor.

For this case, follow the next steps:

- a) Check for obstructions
- b) Gently close the door by hand
- c) If the fault persists, call a service engineer.

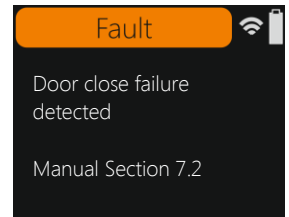

## 7.2 Fault: Door open failure detected

This message indicates that a mechanical failure may have occurred.

This could be several types of failure:

1. Something obstructing the door from opening.
2. Failure of the pneumatic piping connecting the pump module to the door actuator.
3. Failure of the compressor pump that drives the pneumatic cylinders.
4. Failure of the door open pneumatic valve.
5. Failure of the door open sensor.

For this case, follow the next steps:

- d) Check for obstructions
- e) Gently open the door by hand
- f) If the fault persists, call a service engineer.

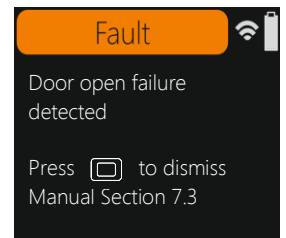

### 7.3 Fault: Lock open failure detected

This message indicates that a mechanical failure may have occurred.

This could be several types of failure:

1. Failure of the pneumatic piping connecting the pump module to the door actuator.
2. Failure of the compressor pump that drives the pneumatic cylinders.
3. Failure of the lock open pneumatic valve.
4. Failure of the lock open sensor

For this case, follow the next steps:

- a) Check for obstructions
- b) Gently open the lock by hand
- c) If the fault persists, the lock open sensor maybe faulty, override by **Press** and **Hold** the squares button until the message is removed (roughly 2 seconds)
- d) Inform a service engineer

Note: By activating the override for the lock open, the operator must open the lock in order that the door can close properly

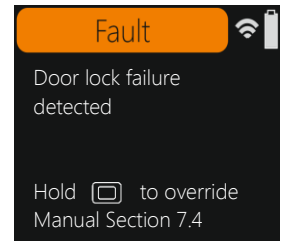

### 7.4 Fault: Lock close failure detected

This message indicates that a mechanical failure may have occurred. This could be several types of failure:

1. Something obstructing the lock from closing.
2. Failure of the pneumatic piping connecting the pump module to the lock actuator.
3. Failure of the compressor pump that drives the pneumatic cylinders.
4. Failure of the lock close pneumatic valve.
5. Failure of the lock closed sensor

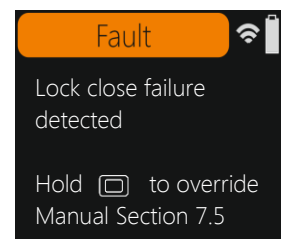

For this case, follow the next steps:

- a) Check for obstructions
- b) Gently close the lock by hand
- c) If the fault persists, the lock close sensor maybe faulty, override by **Press** and **Hold** the squares button until the message is removed (roughly 2 seconds)
- d) Inform a service engineer

Note: By activating the override for the lock close, the operator must close the lock after the door has closed.

## 7.5 Fault: Pump overload detected

The pump for the Poolpod Platform door has a thermal overload fuse built in. A trip in the fuse has been detected: wait for 5 minutes for the fuse to reset. If the message persists, contact a service engineer.

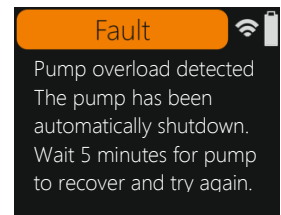

## 7.6 Fault: Position sensing inconsistent detected

Switch the power off, then on the Poolpod platform.  
If this message persists, contact service engineer.

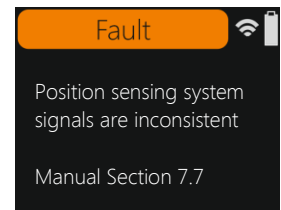

## 7.7 Fault: Safety monitor permanently tripped

Switch the power off on the PoolPod platform. Remove the battery, re-insert and power on. If this message persists, contact service engineer.

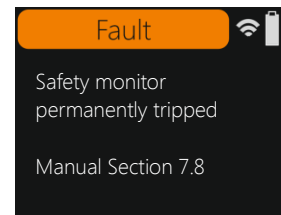

## 7.8 Fault: Left RFID button permanently pressed

The control buttons on the left hand side of the platform (left RFID) have a fault. To operate the lift, this must be disabled. **Press and Hold** the squares button for 2 seconds.

If this message persist, contact service engineer.

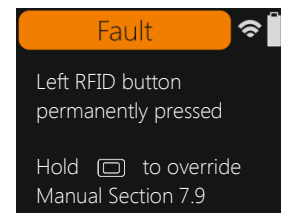

## 7.9 Fault: Right RFID button permanently pressed

The control buttons on the right hand side of the platform (left RFID) had a fault. To operate the lift, this must be disabling. Press and Hold the squares button for 2 seconds.

If this message persist, contact service engineer.

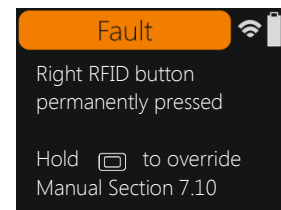

## 7.10 Fault: Power on switch permanently pressed

A problem has been detected with the power on switch. **Press and Hold** the squares button to dismiss this message.

Note: the operator will be unable to turn off the platform. To turn off remove the plug from the

Battery and contact a service engineer.

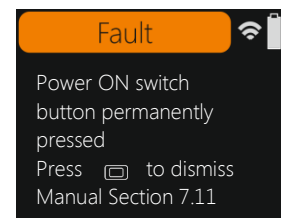

## 8 Moving the Poolpod around

The Poolpod must be moved using the specially designed trolleys. Make sure to follow the next steps:

### 8.1 Preparing the Poolpod for transportation

- Ensure the Poolpod is in the compact ' Home' position.
- Remove the battery from the Poolpod Platform.
- Make sure that the door is locked.
- Remove the anchor bolts.

### 8.2 Inserting the wheel-sets and jacking up the Poolpod

- Make sure both jacks are set to the lowest point. This is done by turning the jacking screw clockwise.
- Insert jacking forks of the left wheel-set into the two corresponding jacking point holes in the side of the Poolpod' s base making sure they are pushed all the way into the holes.
- Repeat for the right side.
- Using the 10mm hex-socket tool, jack the left side trolley. Turn the jacking screw anticlockwise.
- Make sure that the wheels are always kept perpendicular to the Poolpod.
- One person should remain at the left side wheels. Hold the Poolpod steady whilst the right side is jacked.
- Repeat jacking process on the right side.
- Take special care not to put feet, hands or any part of the body under the Poolpod while it is raised.

### 8.3 Relocating the Poolpod

- Take special care in relation to the camber of pool decks around the pool-edge. The slope will always cause the trolleys to steer towards the pool.
- Steer the Poolpod away from the pool and stay as close to the back wall as possible.
- Push or pull the Poolpod using the trolley handle.

- Note the large turning circle. You may need to make pointed turns using the steering of both front and back wheels.
- When Poolpod is in the desired position, it must be lowered to the floor. The Poolpod should never be left unattended in the jacked position.

#### 8.4 Relocating the anchor points:

- Jack up Poolpod in the same manor previously described.
- While moving Poolpod back along the poolside, stay close to the back wall and
- remember to be careful of pool-side camber.
- Only steer the trolleys towards the poolside when you get close to anchor points.
- Steer the Poolpod so that the front edge is parallel to the pool edge.
- Locate the anchor holes on the back of the Poolpod to the anchor points on the poolside.
- Lower one of the Trolleys to the deck, ensure you maintain the alignment with the hole.
- Locate the MIZ Anchor bolt (Always use Poolpod supplied MIZ bolt) and turn in 2 full turns using the 10mm hex-socket tool.
- Lower the second trolley making sure the anchor is aligned with the hole.
- Tighten both anchor bolts so that pod is secure. (You do not need to fully tighten anchor bolts however).

##### A. Insert the trolley

##### Equipment Required

- 10mm hex-socket tool
- Left wheel-set
- Right wheel-set
- The operators H&S assessment may require protective footwear





## B. Anchor Points





# 9 EC Declaration of conformity

## EC Declaration of Conformity

In accordance with BS EN ISO/IEC 17050-1:2004

We: Poolpod Products Ltd

of: Unit J1/ J2, 24 Craigmont St, Glasgow, G20 9BT Hereby declare that:

Equipment Swimming Pool Access Pool Lift System

Model name/number: Poolpod PPI\_1 in accordance with the following Directives:

2006/95/EC Conforms with the safety objectives of the Low Voltage Directive and its amending directives

89/336/EEC Conforms with the essential protection requirements of the Electromagnetic Compatibility Directive and its amending directives

98/37/EEC Conforms with the essential requirements of the Machinery Directive and its amending directives

93/42/EEC Conforms with essential requirements of the Council Directive concerning medical devices and its amending directives

The Poolpod Technical files: EMCD, LVD, MD and MDD show the specification to which the equipment has been designed and manufactured to.

I hereby declare that the equipment named above has been tested and found to comply with the relevant sections of the above referenced specifications. The unit complies with all essential requirements of the Directives.

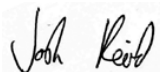
Signed by:  (responsible person)

Name: Josh Reid

Position: Director



Done at: Poolpod Ltd, Craigmont St, Glasgow, On 11/03/2013



## Poolpod Products Ltd

Unit J1/ J2, 24 Craigmont Street  
Glasgow, G20 9DT

Company registered in Scotland: SC 272962

Website: [www.poolpodproducts.com](http://www.poolpodproducts.com) Email:

[poolpod@corepdgroup.com](mailto:poolpod@corepdgroup.com)

Tel: +44(0) 141 237 2127